

BiWaze® Cough System—a bench study evaluation and comparison of cough efficiency

Patrik Malone RRT

Robert DiBlasi RRT-NPS, FAARC

Seattle Children's Hospital,
Seattle, Washington, USA

Introduction

An effective cough relies on the ability to take a slow deep breath followed by the generation of high intrathoracic pressure to promote dynamic airway compression and increase expiratory airflow velocity to remove mucus and other foreign debris.¹ When a person is unable to cough effectively due to muscle weakness or lung disease, techniques are required to either augment or assist their ability to cough. A common respiratory therapy for an ineffective cough is called Mechanical Insufflation - Exsufflation or MIE therapy. MIE therapy devices mimic a person's natural cough with a simulated cough. A typical simulated cough cycle includes applying a positive pressure or *insufflation* to inflate the lungs, quickly followed by negative pressure or *exsufflation* to remove the air and mucus from the lungs, and a timed pause for the patient to rest before the next cough cycle. MIE therapy can be used with pediatric to adult patients in the Intensive Care, Acute Care, and home care environments.

The general thought is that when MIE therapy is combined with High Frequency Oscillations (HFO), it could enhance lung volume on inhalation, recruit collapsed airways and alveoli and improve cough efficiency. HFO superimposes small compressions in pulmonary pressure and flow similar to chest physiotherapy intended to assist in mobilizing secretions from peripheral airways to larger conducting airways so that they can be coughed up and expectorated.² However, there is not a lot of clinical evidence to support the efficacy of MIE therapy with HFO for airway clearance.

Many patients that receive MIE therapy for airway clearance also require noninvasive or invasive mechanical ventilation. It is common clinical practice to disconnect patients from the ventilator in order to receive MIE therapy.

The abrupt disruption in ventilation can result in acute lung deflation due to transient loss of Positive Inspiratory Pressure (PIP) and Positive End-Expiratory Pressure (PEEP). Repeated disconnection from mechanical ventilation and acute deflation has been shown to result in sustained changes in altered lung mechanics, hypoxia, alveolar de-recruitment, reduced lung volume, increased pulmonary edema and injury, and hemodynamic instability.³ Additionally, studies in critically ill subjects have shown that by applying a negative pressure with suctioning to the lungs, which is commonly done in combination with MIE therapy, can produce a marked reduction in lung volume and associated changes in arterial oxygenation.^{4,5}

New Technology

ABM Respiratory Care has an innovative MIE device called, BiWaze® Cough System. BiWaze Cough has a unique two blower design unlike other MIE devices. The two blowers are dedicated to driving and separating the inhaled and exhaled airflow.

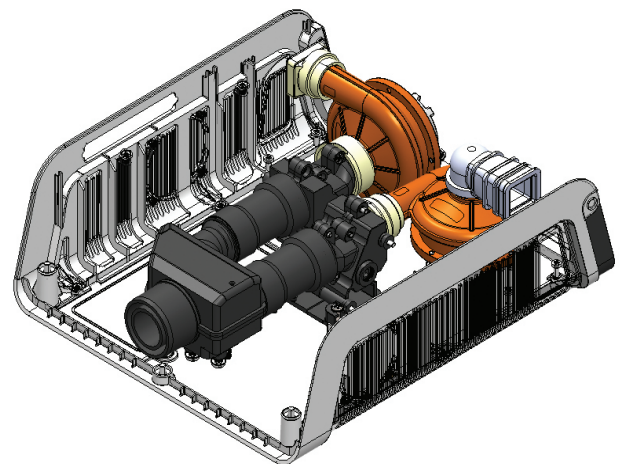

BiWaze Cough two blower design



BiWaze Cough is lightweight (9 lbs.) with a built-in lithium ion battery. It can deliver MIE therapy along with HFO to assist with breaking down and mobilizing retained secretions. BiWaze Cough is designed to prevent lung volume loss and derecruitment by applying a positive pressure during the pause or 'rest' phase between insufflation and exsufflation. The Positive Airway Pressure (PAP) during the pause phase (aka PAP on Pause) feature provides a distending pressure to stabilize the lung volume immediately after a planned disconnection from a ventilator and during exsufflation or suctioning. The PAP on Pause could allow for improved lung mechanics, gas exchange, and lung protection. By maintaining airway pressure similar to PEEP, airways are stented open following exsufflation. PAP on Pause is designed to increase expiratory lung volume and generate a larger inspiratory capacity which could have a beneficial effect on improved cough efficiency. Additionally, PAP on Pause applied between cough cycles could prevent airway collapse, reduce airway resistance and allow better recovery of retained pulmonary secretions.

Study Method

We conducted studies in vitro to evaluate the effects of BiWaze Cough on flow and pressure within a mechanical lung model during assisted cough maneuvers at different MIE Insufflation Pressure (IP) and Expiratory Pressure (EP) settings both with and without PAP on Pause and HFO. In addition to testing BiWaze Cough, we wanted to compare performance to a widely used MIE device, the CoughAssist T70 (Philips Respironics, Pittsburgh, PA). The CoughAssist T70 also provides HFO to facilitate mobilization of airway secretions but it does not provide PAP on Pause.

Measurements were taken using a digitally controlled, high-fidelity breathing simulator (ASL 5000; IngMar Medical, Pittsburgh, PA), which uses a screw-drive-controlled piston and mathematical modeling to simulate disease specific pulmonary mechanics. Inspiratory and expiratory resistance, linear and non-linear pulmonary compliance, and chest wall mechanics can be set independently by the user. An adult passive patient model was used to evaluate the performance of each MIE device. The adult lung model was configured with normal pulmonary compliance and increased resistance to mimic airway obstruction from retained secretions. A passive chest wall model (no active breathing efforts) was used to ensure synchrony and isolation of the assisted cough device performance measurements independent of patient spontaneous efforts. The ASL 5000 was configured with an intrinsic lung resistance of 25 cmH₂O/L/s, a lung compliance of 100 mL/cmH₂O, and an uncompensated residual volume (residual volume, RV) of 1.5 L. MIE therapy was delivered to the ASL 5000 lung model using a 7.0 endotracheal tube and a 15mm adaptor. Each MIE device was equipped with a bacterial filter, patient circuit and evaluated for leaks prior to testing. The ASL 5000 data output array provided measurements of airway pressure, alveolar pressure, cough flow acceleration (maximum change of slope in velocity of the exp. flow curve), Peak Cough Flow (PCF, maximum negative value of the slope for the expiratory flow curve, aka Peak Expiratory Flow), as shown in Figure 1.

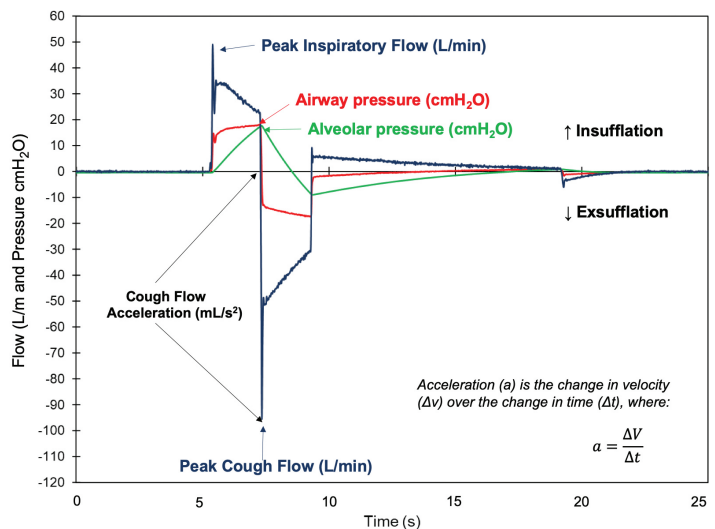

Figure 1: Pressure and flow measurements obtained from the ASL mechanical lung model

Additional calculations were included to evaluate cough efficiency based on the lung model measurements. The Transairway Pressure gradient (ΔP) or driving pressure of

a cough is based on the change in intrathoracic pressure at peak lung inflation followed by rapid expulsion and pressure release at the airway opening that generates high Peak Expiratory Flows (PEF) during a cough. This Transairway Pressure was calculated by taking the absolute difference between alveolar pressure and airway pressure (Palv-Paw) at IP and EP, respectively. The difference or ‘bias’ between Peak Cough Flow and Peak Inspiratory Flow (Δ PCF-PIF) was calculated based on prior findings that greater increases in this value have been shown to correlate with greater mucus displacement from peripheral airways.^{6,7} Descriptive statistics were calculated as mean values for 20 breaths at each testing condition.

We acquired raw data from the lung model and reconstructed the airway and alveolar pressure and flow over time to illustrate HFO waveforms and describe differences in oscillatory output generated by the HFO modality with both MIE devices.

Test Results

Waveform Analysis

BiWaze Cough delivers a controlled gradient to reach target alveolar pressures which results in a constant square inhalation flow pattern and lower inspiratory flows (Figure 2). The expiratory flow profile with BiWaze Cough (Figure 2) shows a brief compression and release in the expiratory flow and pressure waveform at the end of the cough cycle that may be representative of valve closure or flow being dispersed with the dual flow control of (two blower design) BiWaze Cough.

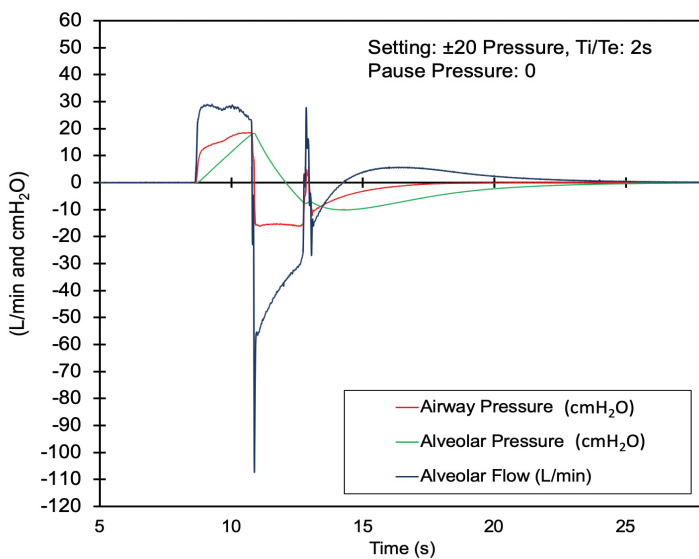

Figure 2: Pressure and flow waveforms of BiWaze Cough (PAP on Pause at 0 cmH₂O)

CoughAssist T70 on the other hand provides a rapid onset inspiratory pressure resulting in a decelerating flow waveform (Figure 3) and higher inspiratory flow. BiWaze Cough showed immediate and sustained airway pressure decay to -15 cmH₂O upon cough initiation; whereas CoughAssist T70 has a less aggressive algorithm with initial airway pressure decay to -12 cmH₂O and achieves -15 cmH₂O just prior to the completion of the cough cycle (Figure 3).

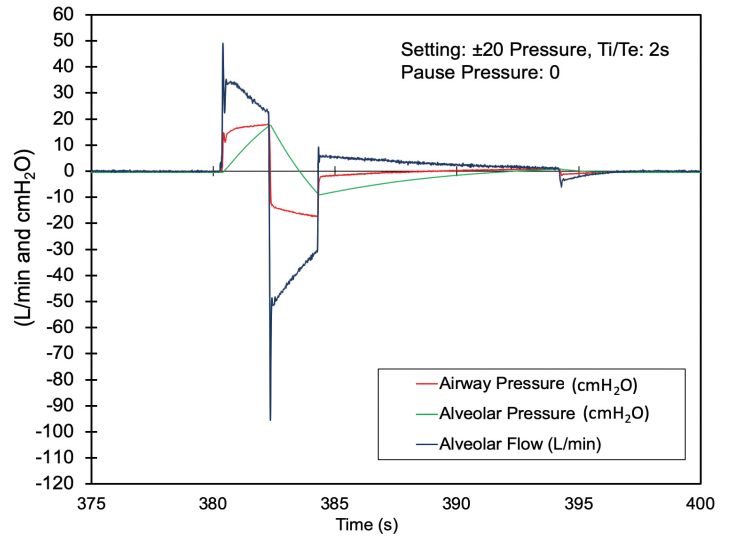

Figure 3: Pressure and flow waveforms of CoughAssist T70

Measured Lung Parameters and Cough Efficiency

The lung model measurements obtained at different IP/EP with BiWaze Cough and CoughAssist T70 are shown in Table 1. The differences in the slope of the EP profile with BiWaze Cough resulted in higher observed Transairway Pressure, Flow Acceleration and Peak Cough Flow (PCF) (Table 1). The combined lower PIF and higher PCF with BiWaze Cough showed greater differences in Δ PCF-PIF at all settings than CoughAssist T70.

MIE Device	IP/EP	PIF (L/min)	PCF (L/min)	Δ PCF-PIF (L/min)	Flow Accel. (mL/s ²)	Transairway Pressure (cmH ₂ O)
BiWaze	±20	30	106	76	72	32
T70	±20	43	89	46	43	31
BiWaze	±30	48	156	108	101	47
T70	±30	55	124	69	58	46
BiWaze	±40	62	186	123	146	65
T70	±40	69	173	104	92	63

Table 1: Effects of BiWaze Cough and CoughAssist T70 on cough efficiency at similar IP and EP settings (no PAP on Pause pressure).

The application of PAP on Pause at 5 and 10 cmH₂O maintained similar cough efficiency values as BiWaze Cough without PAP on Pause (see Table 2).

IP/EP	Pause Pressure (cmH ₂ O)	PIF (L/min)	PCF (L/min)	ΔPCF-PIF (L/min)	Flow Accel. (mL/s ²)	Transairway Pressure (cmH ₂ O)
±20	5	34	107	73	70	31
±20	10	31	109	77	71	31
±30	5	44	159	115	103	48
±30	10	48	158	111	102	47
±40	5	62	186	124	118	65
±40	10	66	186	119	159	61

Table 2: Effects of BiWaze Cough on cough efficiency with different insufflation, exsufflation and PAP on Pause pressures.

In a series of multiple MIE therapy cycles with BiWaze Cough, airway pressures, alveolar pressures, and volumes were observed with and without PAP on Pause (Figure 4.1 and 4.2). The top graph in Figure 4.1 and 4.2 represents airway pressure (orange) and alveolar pressure (yellow). The bottom graph in Figure 4.1 and 4.2 represents volumes (orange) and baseline lung volume (white).



Figure 4.1: IP/EP 20 cmH₂O with no PAP on Pause. The Expiratory Reserve Volume (ERV) is 0 mL above lung Residual Volume (RV), which predisposes patients to alveolar collapse following each cough maneuver.



Figure 4.2: IP/EP 20 cmH₂O with PAP on Pause of 5 cmH₂O. By placing the PAP on Pause pressure at 5 cmH₂O, alveolar and airway pressure is increased at baseline and there was a 450% increase in ERV which would equate to an increase in the Functional Residual Capacity (FRC). Once the PAP on Pause pressure is applied initially in the first breath, it is maintained throughout all coughs with effective Cough Peak Flow (CPF).

The volume above residual volume (1.5 L) in the lung model, or ERV, that contributes to the FRC is visible in Figure 4.2. The ERV was 0 mL with no PAP on Pause and increased to ~400 ml above RV due to the addition of PAP on Pause of 5 cmH₂O. The increased inspiratory airway and alveolar pressures in Figure 4.2 demonstrate that applying a PAP on Pause of 5 cmH₂O, resulted in a nearly 4-fold increase in ERV. This increase in ERV is translated to an increase in FRC or end-expiratory lung volume in a human lung.

Application of HFO with MIE therapy

Descriptive waveform analysis of the High Frequency Oscillation (HFO) feature applied to cough cycles with BiWaze Cough and CoughAssist T70 are shown in Figure 5 displaying pressures and flow and Figure 6 with the flows removed in order to visualize the effects of HFO on airway and alveolar pressures.

The BiWaze Cough generated consistent oscillatory power throughout the cough cycle (IP + EP) and at greater oscillatory flow and airway pressure force than CoughAssist T70. Moreover, the oscillations in airway

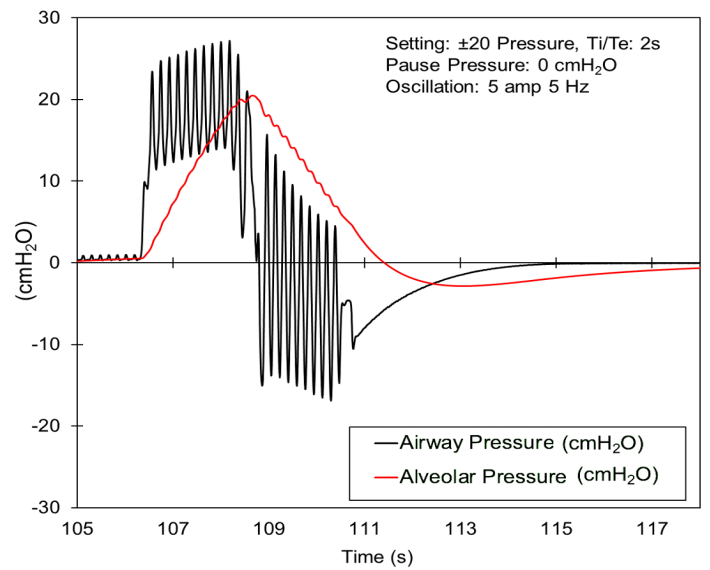
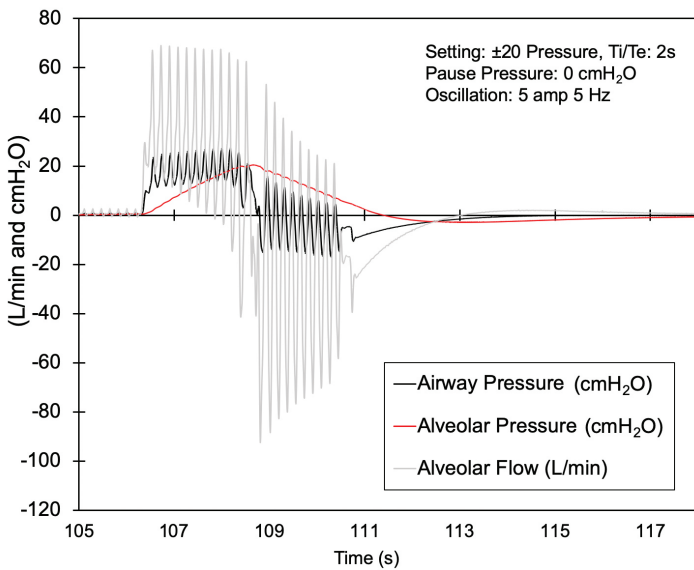
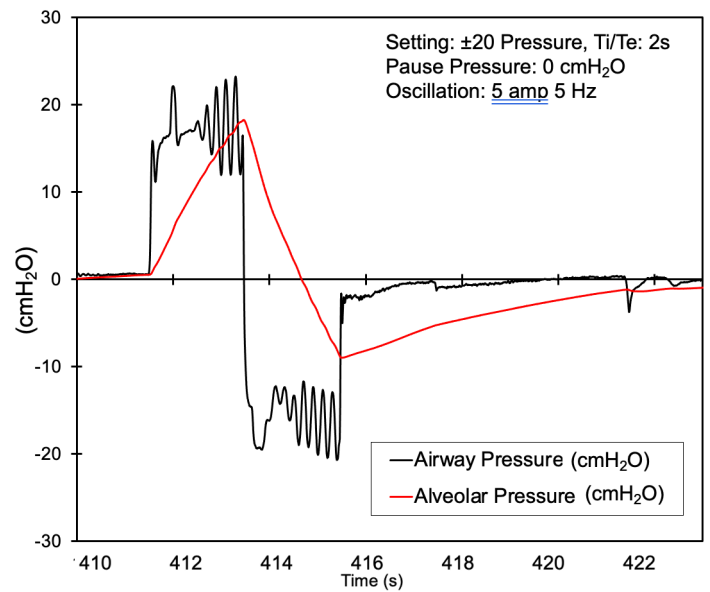
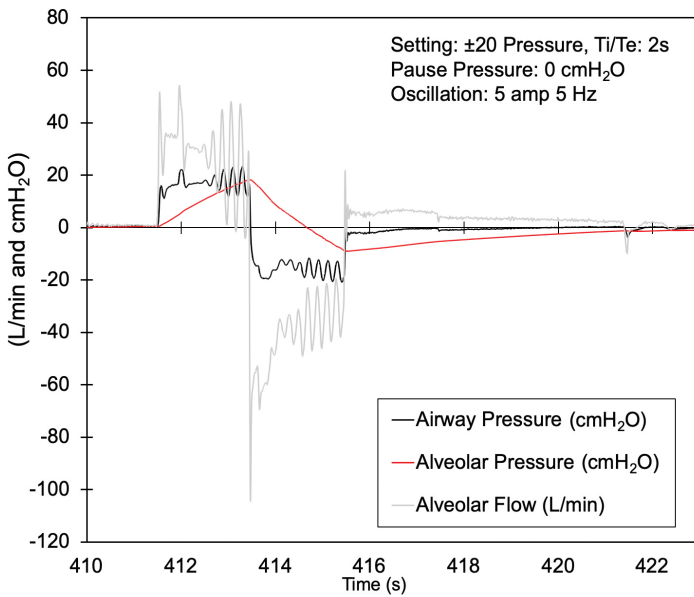

Figure 5: Pressure and flow waveforms of CoughAssist T70 (top) and BiWaze Cough (bottom) with (no PAP on Pause).

Figure 6: Airway and alveolar pressure waveforms of CoughAssist T70 (top) and BiWaze Cough (bottom) showing HFO (no PAP on Pause) with flow data removed.

pressure and flow generated in the lung model were not only lower with CoughAssist T70 but were highly variable throughout the cough cycle. Pressure transmission and oscillatory amplitude was briefly reached at the end of the inspiratory and expiratory phases with CoughAssist T70. The greater oscillatory output with BiWaze Cough resulted in greater transmission of flow and oscillations in the alveolar pressure waveform that were not apparent with the CoughAssist T70 (Figure 6).

Adding PAP on Pause with BiWaze Cough resulted in incremental 'stairstep' increases in airway pressure oscillations on inhalation that resulted in greater transmission of flow and pressure during the MIE cough maneuver (Figure 7). Increases in the PAP on Pause pressure from 5 -10 cmH₂O showed greater pressure transmission of the oscillations to the distal alveolar compartment (Figure 7).

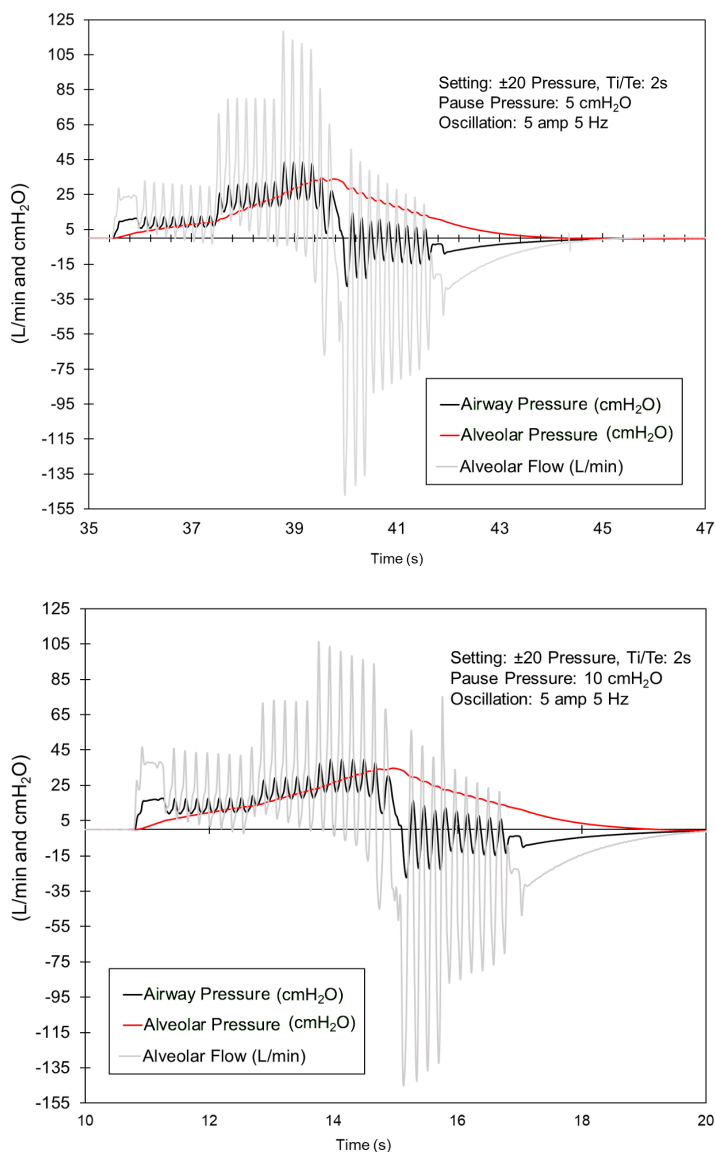

Figure 7: Pressure and flow waveforms for BiWaze Cough HFO with PAP on Pause of 5 cmH₂O (top) and 10 cmH₂O (bottom).

Discussion

This is the first study to evaluate MIE performance between BiWaze Cough and the widely used CoughAssist T70. The BiWaze Cough showed greater Peak Cough Flow (PCF) and lower Peak Inspiratory Flow (PIF) that resulted in higher flow acceleration and Δ PCF-PIF compared to CoughAssist T70 at identical MIE therapy settings. The PAP on Pause feature with BiWaze Cough provided similar increases in PCF as well as increases in Functional Residual Capacity (FRC) or end-expiratory volume than without PAP on Pause. The BiWaze Cough's High Frequency Oscillations (HFO) feature controlled by the dual blower system resulted in greater lung transmission of pressure and flow than with the single blower system of the CoughAssist T70.

There is currently insufficient evidence to indicate whether differences in MIE device performance in bench models could translate to clinically meaningful differences in outcomes in patients. Very few studies have investigated the physiologic effects of MIE in critically ill patients, much less compare different devices. Nonetheless, our bench data show unique differences in flow and pressure delivery between BiWaze Cough and CoughAssist T70 that could generate interest for future research.

During a cough cycle, there is a rapid increase in positive pressure during inhalation that is followed immediately by a rapid airway depressurization. During a physiologic cough the intrathoracic pressure gradient has been shown to range from 30 to 160 cmH₂O in order to generate high cough flows necessary for airway clearance.^{8,9} In our model, similar Transairway pressures were generated that ranged within 1-3 cmH₂O between the two MIE devices. However, the BiWaze Cough was shown to result in greater increases in PCF in the lung model. Unlike the CoughAssist T70, BiWaze Cough had a expiratory airway pressure plateau that was sustained over the initial 2/3 of the exsufflation which may explain why PCF and acceleration of gas during EP were higher with BiWaze Cough. This pressure profile compares well to the rapid deceleration in pressure followed by plateau that has been previously described in subjects with voluntary cough.¹⁰ Interestingly, following the initial 2/3 of the cough cycle, the BiWaze Cough produced a distinct positive pressure inflection and expiratory flow interruption during exsufflation. This is reminiscent of the characteristic partial glottic closure that is typically observed in a voluntary cough.¹¹ The reflex, first described by Williams in 1841¹² and then extensively studied by Korpas and his colleagues¹³ in the 1960s, is referred to as Expiratory Reflex (ER). The ER consists of a glottal closure and forced expiration followed by glottal opening and expulsive airflow, in response to irritation (mechanical or chemical) of the vocal folds or trachea. It is believed that the initial cough reflex and ER that occurs later in the cough phase have quite different functions: cough will clear the lower airways of debris including mucus, while the ER will prevent aspiration of expectorated material into the lungs.¹⁴ In one study, the ER was referred to as "coughing peals" which were shown to achieve similar mechanical effects as voluntary cough (without ER) but were achieved in a much shorter duration when ER was present.¹⁵ BiWaze Cough may provide realistic mechanisms that could improve upon cough efficiency,

especially in intubated patients who are unable to perform glottal closure due to physical and mechanical limitations of the endotracheal tube bypassing the vocal cords.

Reduced Peak Cough Flow (PCF) can be due to a number of mechanisms including reduced respiratory muscle strength, lack of coordination of glottic closure and opening, airway obstruction and, age and activity related changes.¹¹ Generally, PCF > 160 L/min is sufficient to eliminate airway debris and secretions during spontaneous cough.¹⁷⁻¹⁸ In clinical practice, cough efficacy with mucus expectoration may require higher PCF in weak or impaired inspiratory and/or expiratory muscles. MIE therapy attempts to increase PCF in patients with impaired cough to assist with airway clearance. The BiWaze Cough achieved values that coincided with this requirement (~160 L/min) when IP/EP settings >20 cmH₂O; whereas CoughAssist T70 did not. The higher PCF resulted in nearly two-fold greater increases in linear air flow velocities (acceleration) with BiWaze Cough. Increased kinetic energy enhances the removal of mucus adhering to the airway through shearing.¹² The ability to generate high flow velocities needed to expel secretions forward with BiWaze Cough's Transairway Pressure could contribute to improved cough efficiency by enhancing the rheological interaction between flowing gas and mucus in the airways.⁸

Our findings showed BiWaze Cough generated large differences in Δ PCF-PIF based on how each of the devices provide IP and EP during MIE assisted cough maneuvers. BiWaze Cough was shown to deliver a controlled gradient to reach target alveolar pressure which resulted in a constant flow square inhalation flow pattern and generation of lower inspiratory flow delivery with Inspiratory Pressure (IP). The physiologic use of linear flows during inhalation is common prior to initiating a natural cough in humans.⁹ The peak flow increase at the onset of IP with CoughAssist T70 based on the preset pressure control level generated higher inspiratory flows. As mentioned previously, high kinetic energy from high velocity gas affects movement of secretions within the airways. As such, there could be some benefit for applying linear inspiratory flows over a longer inspiratory time in order to reduce airflow velocities and prevent dislodgement and displacement of airway secretions into the distal airways prior to MIE cough maneuver.

In airway clearance studies with mechanical ventilation, when PIF >PEF, an inspiratory flow bias may lead to increased risk of embedding pulmonary secretions.⁷

The flow bias difference (PEF – PIF) between the peak flows that may affect mucus transport by this mechanism include inspiratory-expiratory air velocity, viscosity of mucus, and thickness of the mucus layer.¹² One animal study reported mucus displacement only occurred once an average PEF-PIF difference of 34 L/min was obtained.¹⁹

MIE is commonly applied with fast insufflation-exsufflation pressures to achieve high Peak Expiratory Flow (PEF) in order to assist airway clearance.²⁰⁻²¹ Very little attention is given to the fact that long inspiratory times (>1 sec.) are needed in order to fill lung regions that have long time constants due to high resistance from mucus impaction or the fact that high Peak Inspiratory Flow (PIF) may impair secretion removal.²¹ Volpe et al.²¹ showed in a MIE study *in vitro* that the PEF – PIF difference and MI-E pressure gradient were significantly correlated with mucus displacement, whereas the PEF was not. The PEF-PIF difference observed from these prior studies is identical to the PCF-PIF difference (Δ PCF-PIF) generated in our studies and is likely to be a key determinant for secretion clearance with MIE that can be used to infer the efficacy of airway clearance techniques in critical care patients in the future.

Investigators have reported that MIE maneuvers could be optimized by applying slow lung insufflation, which could reduce the PIF and, consequently, increase the expiratory flow bias (Δ PCF-PIF) to improve cough efficiency by setting EP>IP.²⁰ We demonstrated that BiWaze Cough was shown to generate lower inspiratory flows and greater PCF than CoughAssist T70 that did not rely upon having to set separate IP and EP settings. Our findings with BiWaze Cough showed large differences in Δ PCF-PIF that coincided with values of PEF-PIF differences (>34 L/min) that have been shown to be effective for removing airway secretions. The BiWaze Cough may provide major benefits for improving MIE efficacy with assisted cough maneuvers.

There are several concerns regarding use of the MIE therapy in critically ill patients which include risk of deterioration, large airway collapse during exsufflation with high negative pressures, and loss of Functional Residual Capacity (FRC) with prolonged exsufflation time. In a recent review, this limitation was addressed as a major concern that has not been investigated properly; could the use of high EP reduce the end-expiratory volume leading to hypoxemia and lung injury or, on the contrary, does it cause airway collapse that would prevent this from happening.²⁰ In addition to the MIE therapy itself, critically ill patients with repeated disconnection from the ventilator for MIE therapy and

suctioning following therapy, the lungs are exposed to rapidly changing conditions, and it could take some time for patients to stabilize upon return to a mechanical ventilator or noninvasive support. An additional feature of BiWaze Cough that is not found in CoughAssist T70 is the option to set PAP on Pause. We showed in a mechanical lung model of airway obstruction that small increases in PAP on Pause could translate to large increases in Expiratory Reserve Volume (ERV) that could stabilize end-expiratory lung volumes and Functional Residual Capacity (FRC) in patients with poor pulmonary compliance following disconnection from ventilatory support. This could have a profound impact on patient stabilization and ability to tolerate MIE therapy following disconnection from positive pressure or suctioning or reducing airway collapse when using high Expiratory Pressure (EP) with MIE therapy.

We provided some descriptive waveform analysis using both BiWaze Cough and CoughAssist T70 High Frequency Oscillations (HFO) while being applied to MIE therapy. The BiWaze Cough showed consistent airway pressure and flow oscillations throughout the entire cough cycle. The CoughAssist T70 had lower amplitude pressure and flow oscillations that were highly variable when compared to BiWaze Cough. The ability to provide MIE therapy combined with PAP on Pause and effective HFO represents an exciting novel development in airway clearance with BiWaze Cough.

In summary, based on measurements in a simulated lung model, the BiWaze Cough is effective in maximizing Peak Cough Flow (PCF) and airflow velocity within a standard range of pressure and time settings. Application of PAP on Pause and effective HFO (due to the dual blower design) are two features that are likely to result in more effective airway clearance and improved FRC with BiWaze Cough. These developments in MIE technology present greater options for clinicians providing bedside airway clearance therapy in patients with weak or ineffective cough.

References

1. The development of cough D.E. Leith *Am. Rev. Respir. Dis.*, 131 (5) (1985), pp. S39-S42.
2. Chatburn RL. High frequency assisted airway clearance. *Respir Care*. 2007;52(9):1224-35
3. Katira BH, Engelberts D, Bouch et al. Repeated endo-tracheal tube disconnection generates pulmonary edema in a model of volume overload: an experimental study. *Crit Care*. 2022;18;26(1):47.
4. Maggiore SM, Lellouche F, Pigeot J, et al: Prevention of endotracheal suctioning-induced alveolar derecruitment in acute lung injury. *Am J Respir Crit Care Med* 2003; 167:1215–1224.

5. Lasocki S, Lu Q, Sartorius A, et al: Open and closed-circuit endotracheal suctioning in acute lung injury: Efficiency and effects on gas exchange. *Anesthesiology* 2006; 104:39–47.
6. Volpe MS, Adams AB, Amato MB, Marini JJ. Ventilation patterns influence airway secretion movement. *Respir Care* 2008;53(10):1287-1294.
7. Volpe MS, Guimarães FS, Morais CC. Airway Clearance Techniques for Mechanically Ventilated Patients: Insights for Optimization. *Respir Care*. 2020 65(8):1174-1188.
8. Ross BB, Gramiak R, Rahn, H. Physical dynamics of the cough mechanism. *J Appl Physiol*. 1955 Nov;8(3):264-8.
9. Umayahara Y, Soh Z, Sekikawa K, Kawae T, Otsuka A, Tsuji T. Estimation of Cough Peak Flow Using Cough Sounds. *Sensors*. 2018; 18(7):2381. 6.
10. Bianco S, Robushi M. Mechanisms of cough. In: Braga PC, Allegra L, editors. *Cough*. New York: Academic Press; 1987. p. 95–108.6.
11. Fontana GA, Widdicombe J. What is cough and what should be measured? *Pulm Pharmacol Ther*. 2007;20(4):307-12.
12. Williams CBJ. Report of experiments on the physiology of the lungs and air-tubes. *Rep Br Assn Adv Sci* 1841;August:411–20.
13. Korpas J, Tomori Z. Cough and other respiratory reflexes. Karger: Basel; 1979. p. 1–281.
14. Widdicombe J, Fontana G. Cough: what's in a name? *Eur Respir J* 2006; 28:10–5.
15. Smith JA, Aliverti A, Quaranta M, McGuinness K, Kelsall A, Earis J, Calverley PM. Chest wall dynamics during voluntary and induced cough in healthy volunteers. *J Physiol*. 2012 1;590(3):563-74
16. Chang AB. The physiology of cough. *Paediatr Respir Rev*. 2006;7(1):2-8.
17. Fontana GA, Widdicombe J. What is cough and what should be measured? *Pulm Pharmacol Ther*. 2007;20(4):307-12.
18. Criteria for extubation and tracheostomy tube removal for patients with ventilatory failure. Bach JR, Saporito JR, *Chest*, 110 (6) (1996), pp. 1566-1571.
19. Li Bassi G, Saucedo L, Marti JD, Rigol M, Esperatti M, Luque N et al. Effects of duty cycle and positive end-expiratory pressure on mucus clearance during mechanical ventilation. *Crit Care Med* 2012;40(3):895-902.
20. Chatwin M, Toussaint M, Gonçalves MR, Sheers N, et al. Airway clearance techniques in neuromuscular disorders: A state of the art review. *Respir Med*. 2018 ;136:98-110.
21. Volpe MS, Naves JM, Ribeiro GG, Ruas G, Amato MBP. Airway Clearance With an Optimized Mechanical Insufflation-Exsufflation Maneuver. *Respir Care*. 2018;63(10):1214-1222.

BiWaze® and ABM Respiratory Care™ are registered trademarks of ABMRC, LLC.

©2022 ABMRC, LLC. ALL RIGHTS RESERVED
PRTN-1585539264-146 REV. 2.0 APR-2022 ENG US

For further information about this product or a service, visit our webpage: www.abmrc.com or call customer service: 1-877-ABM-RC01 (877-226-7201)

